

Product Information

PI 49 e

Disc-type tool turret
without tool drive

0.5.480.5xx

with tool drive (axial)

0.5.473.5xx

Table of Contents

**Disk-type tool turret without tool drive
Series 0.5.480.5xx**

Description	4
Technical Data	6
Admissible Loads	8
Selection of the Tool Turret Size	10
Dimensions	11
Precision	12
Fluid Rotary Feed-Through	12
EK 502 Control Unit	12

**Disk-type tool turret without tool drive (axial)
Series 0.5.473.5xx**

Description	13
Performance Data on the Tool Coupling	14
Performance Diagram	16
Admissible ON Time of the Tool Drive	16
Cutting Performance	17
Alternate Configurations	18
Tool Arrangement	18
Type Key	20
Ordering Details	21

Please request the following document if required: PI 18 configuration instructions

NOTE

The information contained in this Product Information is based on the knowledge available at the time of printing. We reserve the right to perform modifications within the framework of continuous further development.

Disk-type tool turret

Without tool drive **0.5.480.5xx** series

Description

Tool turret series

- Without tool drive 0.5.480.5xx
 - With axial or radial tool holder

The approved tool turret is suitable for

- Use on turning machines for forward and reverse machining.
- Medium-sized series production

Features

- Robust structure
- Simply control
- Short switching times
- Electromechanical drive for swivelling and locking, thus no additional medium required
- Use of absolute encoders – no reference point travel required
- High degree of stability due to high locking forces
- Locking with special three-part Hirth serration
- Not affected by collisions due to
 - Low kinetic energy of the drive
 - Fastening snap ring groove for the tool disk
- Direct control with machine control or EK 502 SAUTER control unit
- Can be installed in any position
- Mechanically largely connection-compatible with series 0.5.440.xxx and 0.5.680.xxx

- Options
 - Block-shaped housing or with flange fitting for especially high degree of rigidity
 - Installation of cooling plates for water cooling under the highest standards of thermal stability.
 - Central rotary feed-through for fluid-actuated tools and for a high-pressure cooling lubricant supply
 - Attachment of sensors for cutting force monitoring

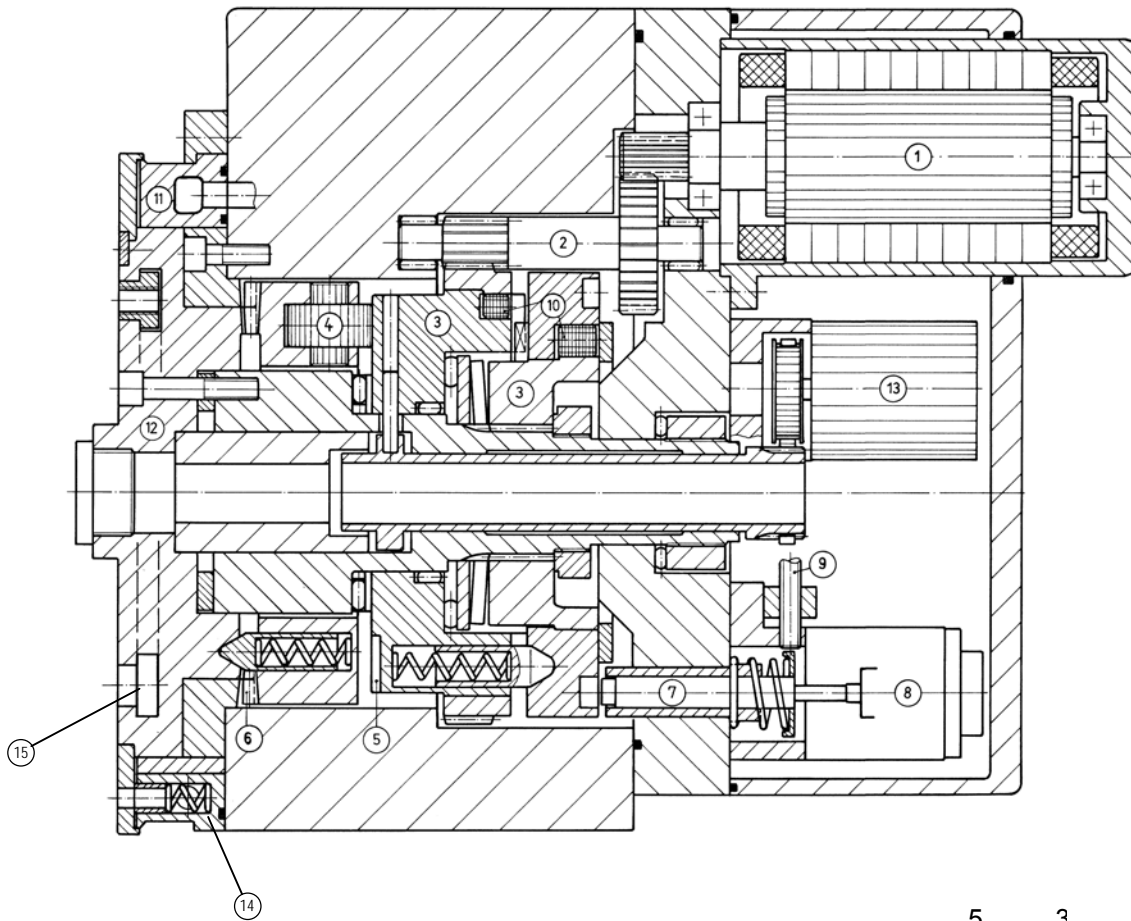

- 1 Drive motor
- 2 Planetary gear box
- 3 Turning drive
- 4 Curve rollers
- 5 Locking curve
- 6 3-part Hirth serration
- 7 Pre-indexing bolt
- 8 DC stroke magnet
- 9 Pre-indexing control switch
- 10 Attenuation system
- 11 Cooling lubricant ring
- 12 Tool disk accommodation
- 13 Absolute encoder switch absolute
- 14 Coolant valve
- 15 T ring groove

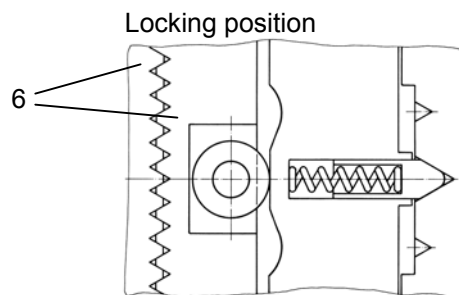
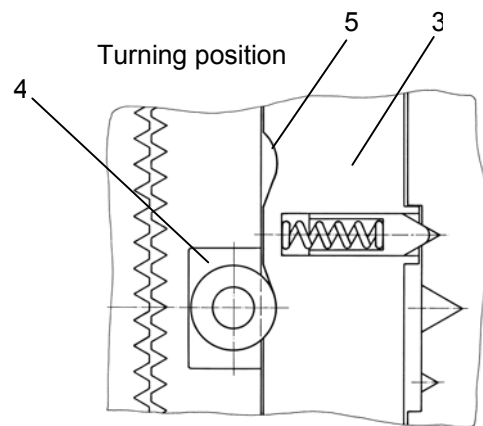

Technical Data

Series				
Disk-type tool turret 0.5.480.5xx				10
Number of switching positions				8 or 12
Admissible tangential load (turret locked)			kNm	0.3
Adm. moment of inertia (tool disk and tool holder ¹⁾)			Kgm ²	0.15 0.20 0.28
Admissible out of balance (load moment) due to tooling			Nm	6
Switching times				
Rotating ²⁾ tool disk (incl. unlocking, rotating tool disk, locking)				
30° per step (12-fold)		s	0.38	0.45 0.52
45° per step (8-fold)		s	0.45	0.53 0.62
Only turning ²⁾				
30° per step (12-fold)		s	0.14	0.16 0.20
45° per step (8-fold)		s	0.20	0.25 0.30
Adm. switching frequency (average switch angle $\varphi_m = 90^\circ$) ²⁾				
30° per step (12-fold)		rpm	18	16 14
45° per step (8-fold)				
Mass				
Mass (without tool disk)			kg	14
Cooling lubricant				
▪ Standard			bar	
▪ Medium pressure valve			bar	
▪ High-pressure cooling lubricant supply			bar	
Admissible ambient temperature				°C

Size																	
12			16			20			25			32			40		
8 or 12																	
0.6			1.3			3.0			6.0			12			24		
0.30	0.60	1.4	0.8	1.4	3.2	1.8	3.2	7.5	4.0	7.0	18.0	9.0	28.0	40.0	20.0	50.0	100.0
15			32			63			125			200			320		
0.38	0.48	0.73	0.46	0.59	0.84	0.56	0.72	1.02	0.69	0.89	1.32	0.86	1.35	1.64	1.04	1.60	2.22
0.43	0.55	0.86	0.55	0.71	1.01	0.66	0.86	1.22	0.81	1.05	1.58	1.02	1.62	1.97	1.25	1.92	2.67
0.14	0.18	0.29	0.17	0.23	0.34	0.21	0.27	0.40	0.26	0.34	0.52	0.33	0.54	0.66	0.41	0.64	0.90
0.20	0.27	0.44	0.26	0.34	0.51	0.31	0.41	0.60	0.38	0.51	0.78	0.49	0.80	0.99	0.61	0.96	1.35
16	12	9	11	9.5	7	10	8	5.5	7.5	6.3	4.5	5	3.3	2.8	5	4.5	4
23			46			70			135			250			480		
7 – 14 (without filtering)																	
5 .. 25 (filtering < 100 µm)																	
100 (filtering < 25 µm)																	
10 ... 40																	

- 1) Further values for moment of inertia and switching times on request
- 2) The values are valid for 50 Hz operation; deviations of ± 5 % are possible for 60 Hz operation.

Admissible Loads

Admissible loads (reference values)

Note: The diagrams refer to static load.
In the case of impact loads (interrupted cutting) much lower values must be expected.

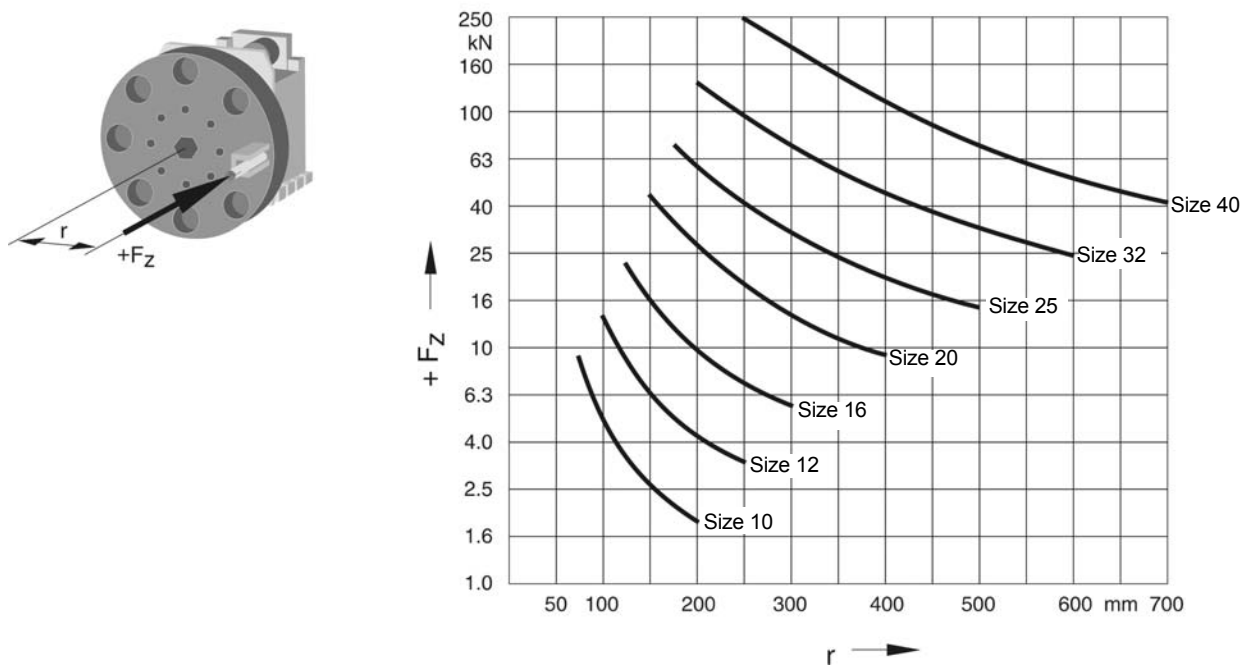
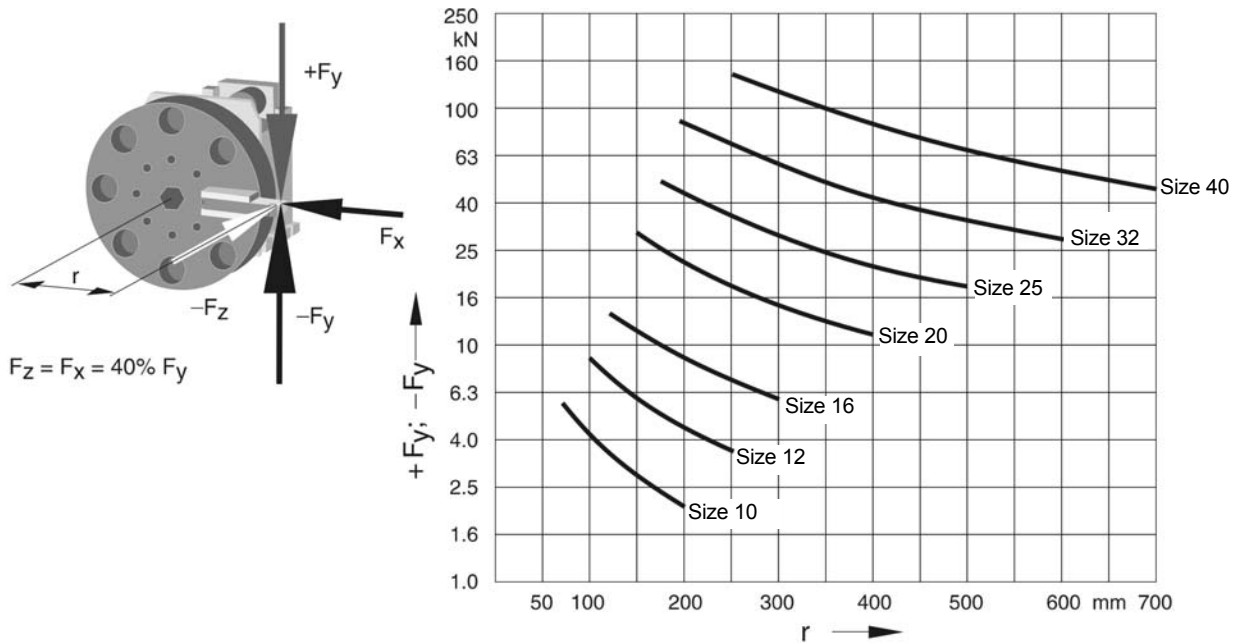

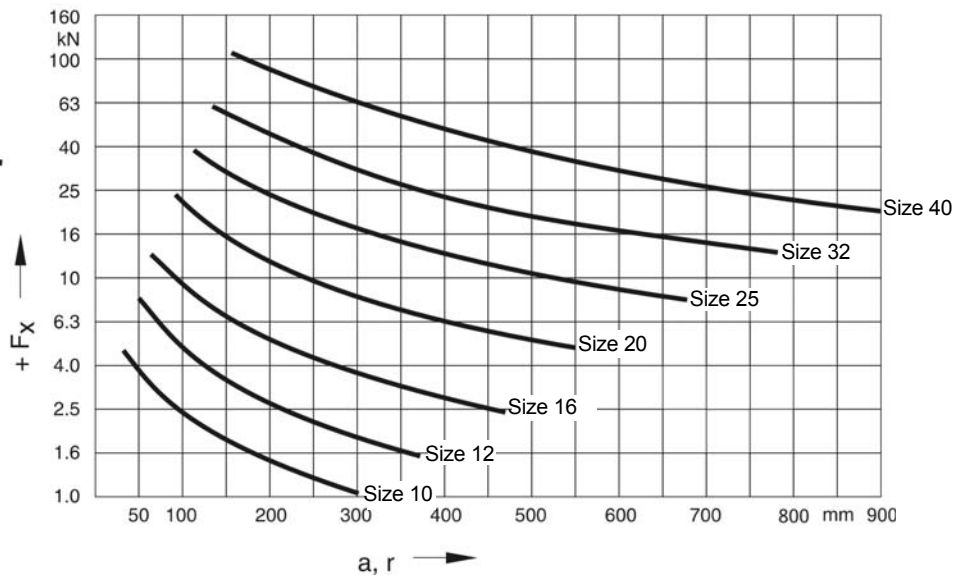
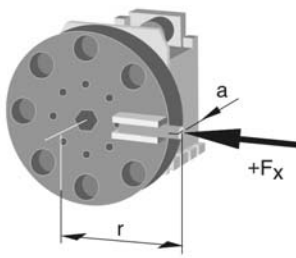
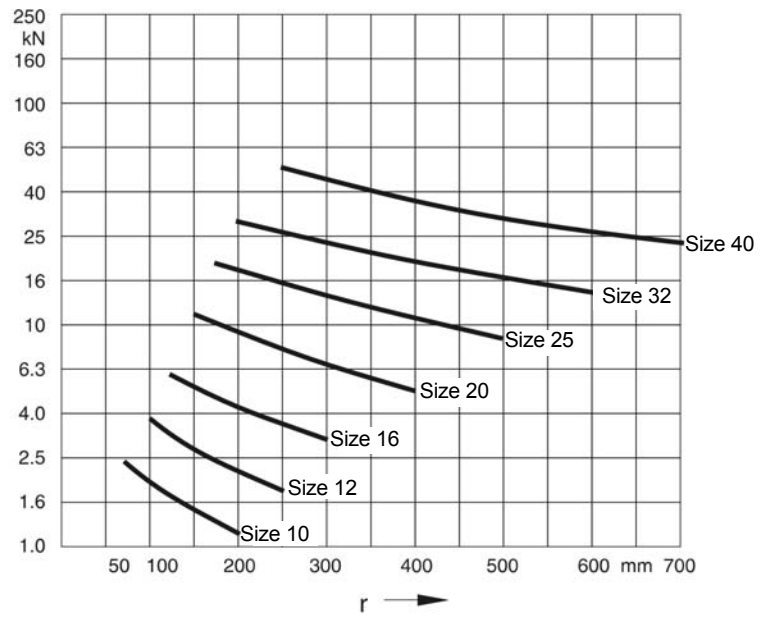
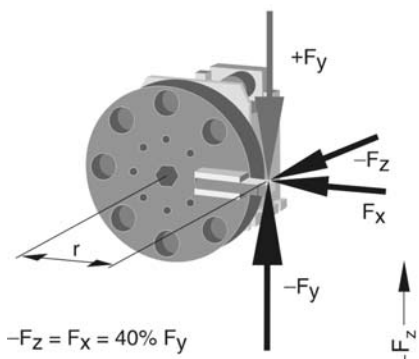

Selection of the Tool Turret Size

Selection of the tool turret size (reference values)

Example

Given machine rating P	kW	35
Desired cutting cross-section A	mm ²	5
Tool overhang r	mm	e.g. 240
Result: Size	0.5.480.520	

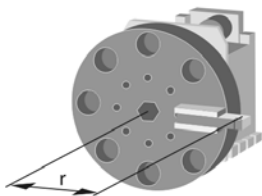

according to machine power
at $v = 200 \text{ m/min}$

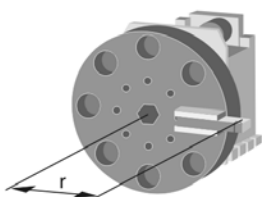
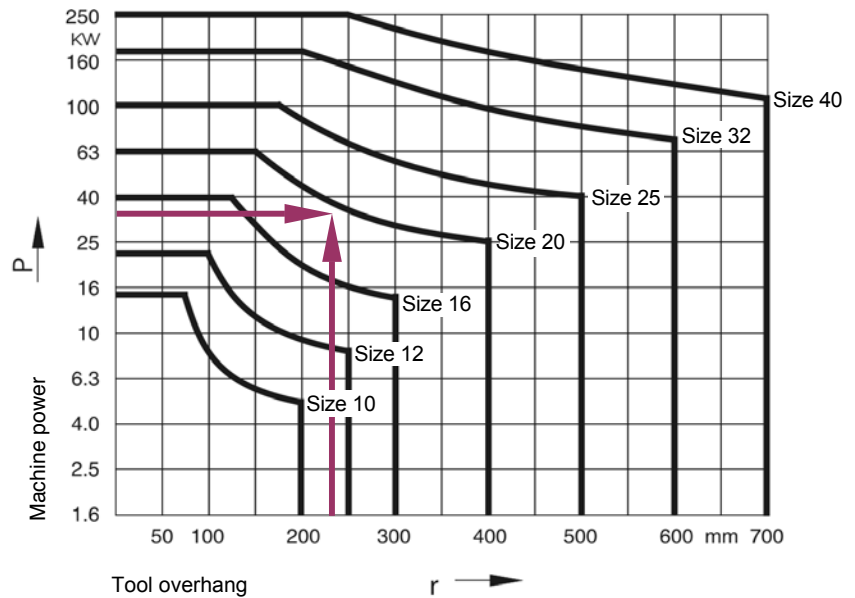

according to
cutting cross-section
at St 60
($k_s = 2200 \text{ N/mm}^2$)

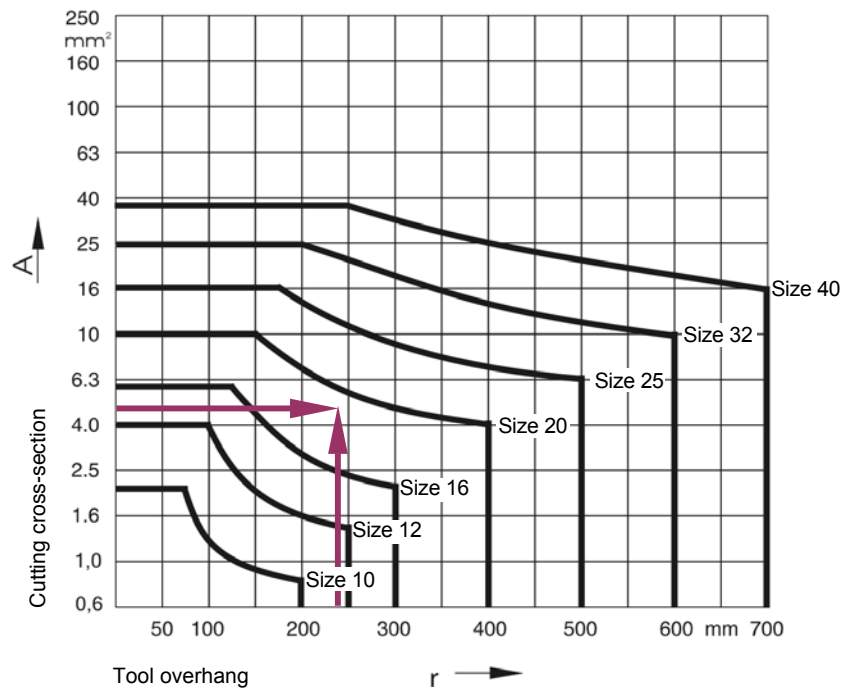

Dimensions

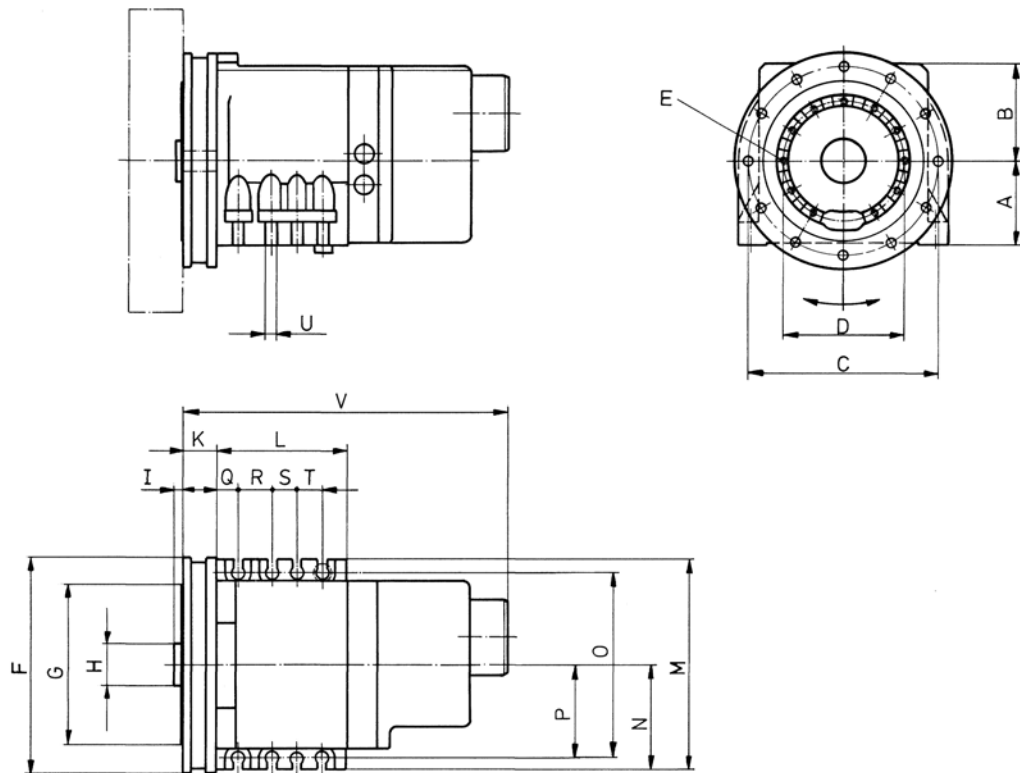

Series	Size								
	10		12		16	20	25	32	40
Disk-type tool turret 0.5.480.xxx	right	left	right	left					
A	50		63		80	100	125	160	200
A ₂					105	150		200	
B	90		102		122	112	138	176	220
C	120		150		190	226	280	352	432
D	70		90		120	145	182	220	300
E	6 x M 6		8 x M 8		8 x M 8	11 x M 10	11 x M 12	15 x M 12	22 x M 12
F	140		175		215	255	318	396	470
G	97		120		154	190	240	296	370
H	25		30		40	50	63	80	100
I	6		8		8	9	10	10	12
K	30		32		40	41	52	62	70
L	100		128		138	155	190	220	340
M	153		185		212	250	315	396	490
N	63	90	85	105	106	125	158	198	245
O	135		165		190	220	280	352	440
P	55	80	75	90	95	110	140	176	220
Q	15		18		18	25	30	34	40
R	60		30		32	40	44	48	60
S	-		60		32	30	43	56	80
T	-		-		32	30	43	48	2 x 60
U for	M 8		M 8		M 10	M 12	M 16	M 20	M 24
V	278		310		352	390	448	516	657

Precision

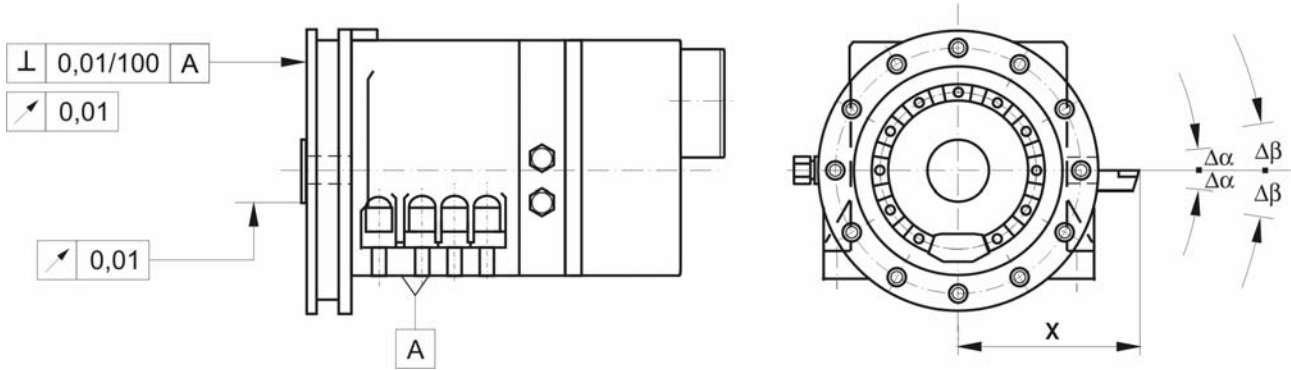

Repeating accuracy

(Multiple approach of a switching position from the same direction)

$$\Delta\alpha = \pm 1,6'' \cong \pm 0,8 \cdot \frac{X[mm]}{100[mm]} [\mu m]$$

e.g. $\pm 0.8 \mu m$ based on a 100 mm radius

Indexing position

(Multiple approach of a switching position from different directions)

$$\Delta\beta = \pm 4'' \cong \pm 2 \cdot \frac{X[mm]}{100[mm]} [\mu m]$$

e.g. $\pm 2 \mu m$ based on a 100 mm radius

Fluid Rotary Feed-Through

Die Revolver sind lieferbar mit einer zentralen Fluid-Drehdurchführung:

- “Uncontrolled” variation - Fluid supply in **all** switching positions
e.g. for sealing air, for gripper actuation
- “Controlled” variation - Fluid supply in **one** switching position
e.g. for KSS, automatic tool change

A maximum of three supply lines are routed through the centre of the turret.

Operating pressure $P_{adm} = 100 \text{ bar}$ (standard)

EK 502 Control Unit

We offer an EK 502 SAUTER control unit in order to control the tool turret. It includes a complete control logic including malfunction monitoring.

Detailed information: PI 42

Disk-Type Tool Turret 0.5.473.5xx series with Axial Tool Drive

Description

These turrets have a modular design. They consist of a basic turret from the 0.5.480.5xx series and a decentralized tool drive mounted in place of the cooling lubricant ring. The tool drive has been designed for individually switchable, **axially** placed tools for **forwards** machining.

The tool drive motor drives the coupling wheel via the spur gear incorporated in the gearbox casing. The relevant tool is switched into the working position by means of the coupling. The drive motor can be located to the side opposite the working position or above the turret casing, depending on the application.

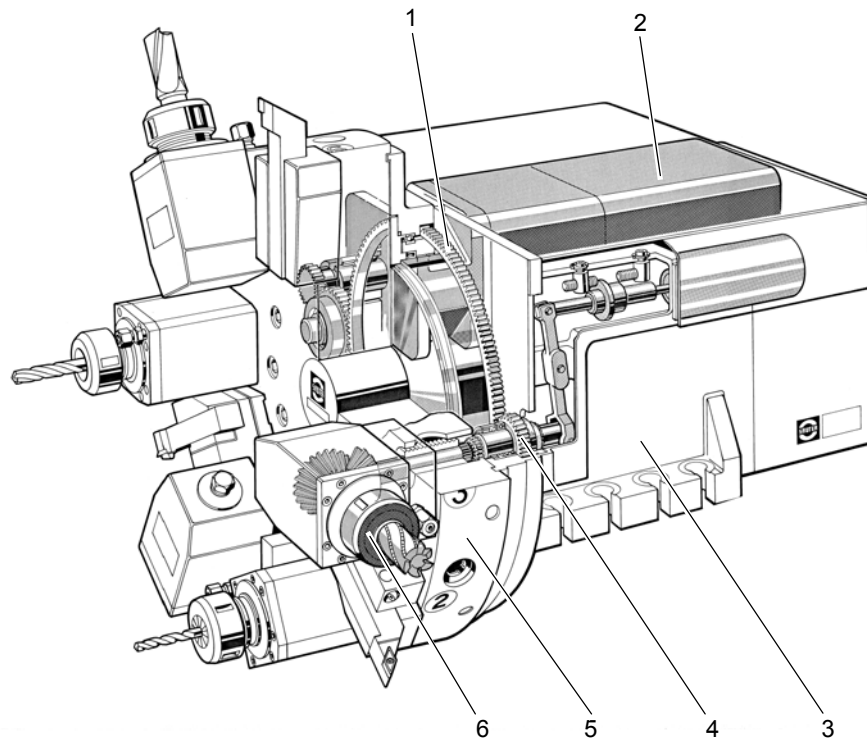

- 1 Spur gear
- 2 Tool drive motor
- 3 Basic turret
- 4 Tool coupling
- 5 Tool disk
- 6 Tool

The tool coupling is designed for spindle heads without the patented spindle locking system. This means that the tools are coupled after searching with the tool drive motor.

The performance data and dimensions of the swivel drive and the turret locking are identical with that of the basic turret series 0.5.480.5xx.



Performance Data on the Tool Coupling

The gearbox is designed for the performance data indicated below for the tool coupling. The actually available performance data depends on:

- the drive motor used
- the speed on the tool coupling
- the duration of activation
- the cutting performance

The values given in the following examples of cutting efficiency can be taken as reliable estimates

Series			
Disk-type tool turret 0.5.473.5xx			
Gearbox performance data	<ul style="list-style-type: none"> ▪ Adm. drive rating ¹⁾ ▪ Adm. torque ²⁾ ▪ Adm. speed ³⁾ 	P_{adm} M_{adm} n_{adm}	kW Nm min ⁻¹
Recommended drive motors ⁵⁾			
Siemens servomotor Type 1 FT 6..			
Gear ratio ⁶⁾ motor speed / tool coupling			$i = n_{mot}/n_2$
Fanuc spindle motor Type Alpha..			
Gear ratio ⁶⁾ motor speed / tool coupling			$i = n_{mot}/n_2$

- 1) The values apply for short-time operation.
- 2) Torque limitation on the motor converter required.
The torque values are indicated for shock-free load (e.g. drilling, thread drilling).
In case of machining processes subject to shock (e.g. milling), the P_c cutting performance must be reduced by 50 % or more without reducing the required speed n_c .
- 3) Higher values on request
- 4) Spindle motor
- 5) Further motors on request
- 6) Further gear ratios on request

Size												
10	12	16	20	25	32	40						
4 8 6000	5 12.5 6000	6 20 5000	8 32 4000	10 63 4000	12.5 130 3200	15 160 2500						
..044..AK..	..062..AK..		..064..AK..	..082..AH..		..086..AH..	..108..AF..		..108..AF..			
1.0	1.5	1.0	1.5	1.0	1.32	1.0	1.63	1.0	1.24	1.0	1.3	1.0
α 0.5	α 1		α 1.5		α 2		α 3		α 8		α 8	
1.0	1.0		1.0		1.0		2.0		1.53		1.53	

Tool Drive Performance Diagram

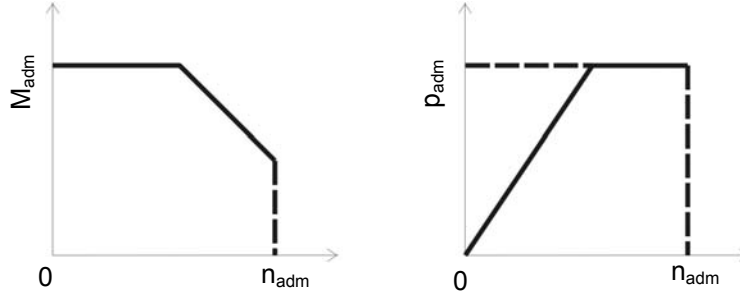

Permissible ON time of the tool drive during short-time operation (reference values)

The actual efficiency (DC) also depends on where the turret is installed and on the operating conditions!

Admissible ON time [OT] (5 min)		100 %	80 %	60 %	40 %	25 %
Admissible drive power and admissible speed	$\left[\frac{P_c}{P_{adm}} \right]$	25 %	40 %	50 %	75 %	100 %
	$\left[\frac{n_c}{n_{adm}} \right]$					

P_c = Required cutting performance [kW]

n_c = Required cutting speed [min^{-1}]

P_{adm} = Permissible drive power [kW]

n_{adm} = Permissible speed [min^{-1}]

(refer to table on pages 14/15)

Example calculation:

Which speed n_c and which power P_c with 40 % OT (5 min) are supported on a tool drive, size 20?

According to the table on p. 14/15, the following values are valid for disk-type tool turrets, size 20:

$P_{adm} = 8 \text{ kW}$, $n_{adm} = 4.000 \text{ min}^{-1}$

For 40 % ED (5 min) according to table p. 16: $\frac{n_c}{n_{adm}} = 75 \%$ and $\frac{P_c}{P_{adm}} = 75 \%$

$$P_c = P_{adm} \cdot \left[\frac{P_c}{P_{adm}} \right] = 8 \text{ kW} \cdot 75 \% = 6 \text{ kW}$$

and

$$n_c = n_{adm} \cdot \left[\frac{n_c}{n_{adm}} \right] = 4.000 \text{ min}^{-1} \cdot 75 \% = 3.000 \text{ min}^{-1}$$

In this example the tool drive can be operated with $P_c = 6 \text{ kW}$ and $n_c = 3000 \text{ min}^{-1}$ for 2 minutes and then it must rest for 3 minutes

Cutting performance in steel St 60

Blunting factor -1.6 on the tool

Examples (non-binding reference values)

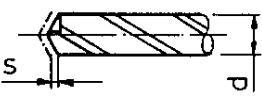
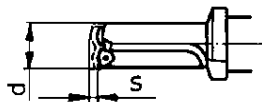
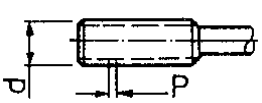
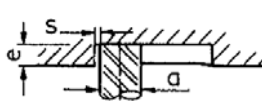
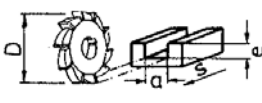
Series			Size						
Disk-type tool turret 0.5.473.5.xxx			10	12	16	20	25	32	40
Drilling HSS spiral drill		d x s mm x mm /U	8 x 0.12	12 x 0.14	14 x 0.16	16 x 0.20	20 x 0.25	32 x 0.20	40 x 0.22
Drilling HM short hole drill		d x s mm x mm /U	12 x 0.05	15 x 0.08	16 x 0.10	20 x 0.12	24 x 0.16	32 x 0.16	50 x 0.12
Thread- drilling		d x P mm x mm	M 8 x 1	M 8 x 1.25 M 16 x 1	M 10 x 1.5 M 24 x 1	M 14 x 2 M 20 x 1.5	M 18 x 2.5 M 36 x 1.5	M 20 x 2.5 M 42 x 2	M 30 x 3.5 M 48 x 3
Keyway cutting Finger milling		a x e x s mm x mm x mm/min	1 x 5 x 45	12 x 8 x 45	16 x 12 x 40	20 x 12 x 40	22 x 25 x 40	30 x 20 x 40	40 x 25 x 50
Keyway cutting Disc cutting		a x e x s mm x mm x mm/min			D = 50 8 x 8 x 45	D = 63 10 x 10 x 40	D = 80 18 x 18 x 40	D = 100 20 x 20 x 40	D = 125 25 x 20 x 40

Alternate Configurations

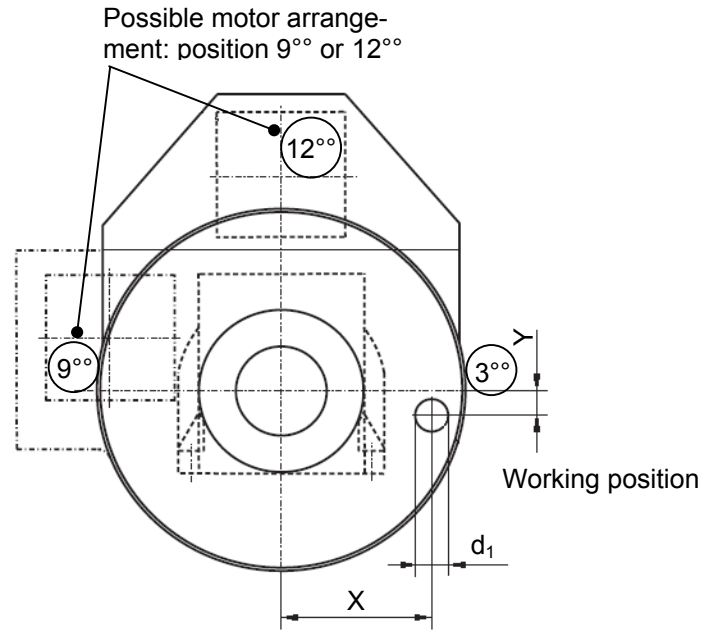
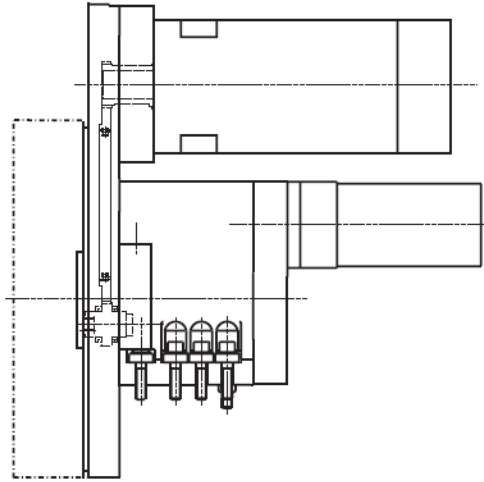

(the cw
turret type is shown)

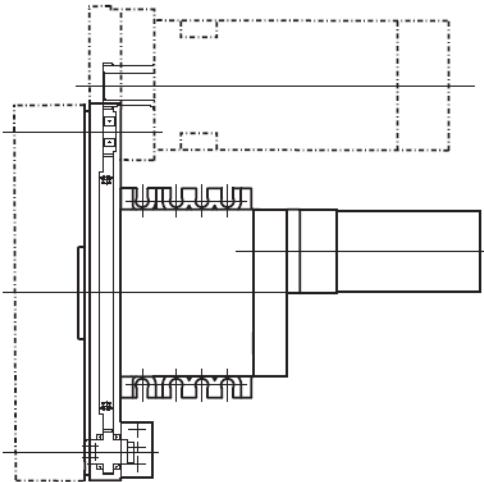

Tool Arrangement

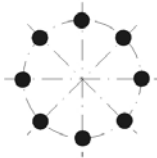

8 pos. – 1 graduated circle

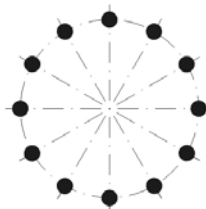

12 pos. – 1 graduated circle

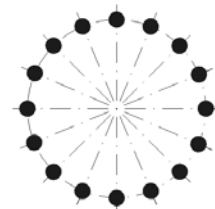

16 pos. – 1 graduated circle

● Position with tool drive
○ Position without tool drive

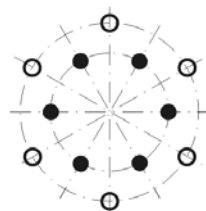

12 pos. – 2 graduated circles

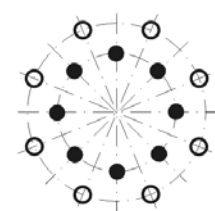

16 pos. – 2 graduated circles

Alternate Configurations

Turret Size	Working position		Motor-position	Coupling profile	Tool holder seat Ø DIN 69880
	x	y			
10	+ 78	0	9°	DIN 5480 - W8 x 0.8	16
	- 78	0	3°		16
12	+ 98.54	- 17	9°	DIN 5480 - W10 x 0.8	20
	+ 100	0	9°		20
	- 100	0	3°		20
	+ 98.54	- 17	9°	DIN 5482 - B15 x 12	30
+ 117.4	- 25	12°	30		
+ 120	0	12°	30		
+ 120	0	9°	30		
- 120	0	12°	30		
16	+ 150	0	9°	30	
	+ 150	0	12°	30	
	+ 155	0	9°	DIN 5482 - B17 x 14	40
	+ 155	0	12°		40
	- 155	0	12°		40
	+ 170	0	9°		40
+ 185	0	9°	40		
25	- 180	0	12°	DIN 5482 - B20 x 17	50
	+ 235	- 70	9°		50
	+ 200	0	9°		50
	+ 200	- 20	12°		50
	+ 210	0	12°		50
32	- 223.6	0	12°	DIN 5482 - B25 x 22	60
	+ 265	- 80	12°		60
40	+ 387.8	- 125	9°	DIN 5482 - B25 x 22	60
	- 265	- 50	12°		60

Variants on **grey** background are preferred

Further variants on request

Type Key

Type Key

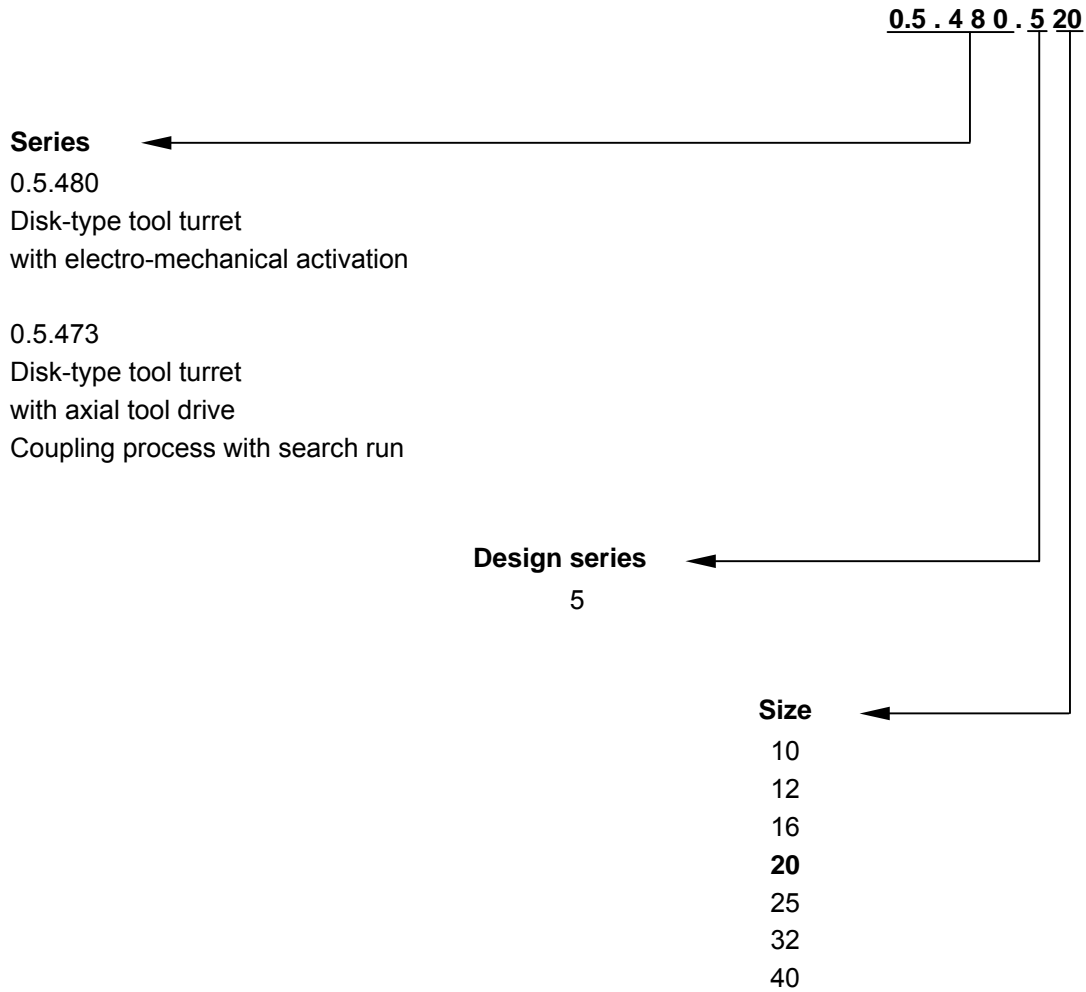

Fax ++49 (0) 7123-926-190



++49 (0) 7123-926-0



info@sauter-gmbh.com



SAUTER Feinmechanik GmbH
Postfach 1551
D-72545 Metzingen
Germany

Firma: _____

Straße: _____

PLZ, Ort: _____

Name: _____

Tel.: _____

Fax: _____

SAUTER disk-type tool turret 0.5.480.5xx / 0.5.473.5xx		
Ordering details	Possible variations	Your selection
Basic turret Size Number of switching positions Moment of mass inertia (tool disk and tool holder) Cooling lubricant pressure Installation position (Position in turning machine) Cw/ccw type	10 / 16 / 20 / 25 / 32 / 40 8 / 12 / 16 0-14 / 5-25 / more	
Tool drive Working position X / Y Motor position Motor used Gear ratio Coupling profile	See page 18 3° / 9° / 12° See page 14 / 15 1.0-1.5, 1.5-2.5 See page 19	
Special requirements: 